

K
RAIN[®]

RFS46[™] **MINI IRRIGATION CONTROLLER**



STATION MODELS: Available in 4 or 6 stations

INDOOR MODEL: Supplied with
120VAC (240VAC International) x 24 VAC
Plug Pack Transformer

INSTRUCTION MANUAL

TABLE OF CONTENTS

FEATURES	1
GLOSSARY	2
PROGRAMMING INSTRUCTIONS	
Introduction	3
Other Functions	4
General tips for programming	4
PROGRAMMING	
Set Current Time & Correct Day	5
Set Calendar (Optional)	5
STEP 1. Set Start Times	6
STEP 2. Set Watering Days	7
Interval Day Selection	7
Individual Day Selection	7
Odd / Even Day Selection	8
STEP 3. Set Station Run Times	8-9
MANUAL OPERATIONS	
System test	10
Run A Single Station	10
Run A Program	11
OTHER FEATURES	
Stop	11
Stacking Start Times	11
Automatic BackUp Program	11
Fitting a Rain Sensor (Optional)	12
Rain Off Mode	13
Water Budgeting	13
INSTALLATION INSTRUCTIONS	
Mounting The Controller	14
Electrical Hook-Up	14
Field Wiring Connections	15
Terminal Block Layout	15
Power Supply Connections	16
Connection Of Valves	16
Pump Hook-Up Connections	17
ELECTRICAL CHARACTERISTICS	18
SERVICING THE CONTROLLER	19
TROUBLESHOOTING	20
SPARE WATERING PLANNER	21

FEATURES

This unit is available in 4 & 6 station configurations. Designed for residential applications, this controller has four separate programs with a maximum of sixteen start times a day. This ensures efficient watering of different garden or turf areas.

These different areas may require individual watering programs and often use different types of sprinklers.

EXAMPLES: Turf areas generally use pop-up sprinklers and require less frequent but heavier watering. However, flower beds use sprays and require more frequent watering. The valves (stations) which water similar areas are often *grouped together and put into the same program as they need to be watered on the same days.*

These stations (valves) will water in sequential order from the lowest number at the start time (or times) nominated and on the days selected. Maximum watering duration for a station (valve) is 12 hours and 59 minutes.

This controller has three types of watering day options. Either individual day selection per program, or a 365 day calendar for ODD/EVEN day watering, interval watering from everyday to every 15th day.

An innovative feature of this controller is the water saver feature which allows quick adjustment of the station watering times by percentage as the seasons change. Another water saving feature is the installation of a rain sensor. This controller has a rain sensor switch in the fascia so you can enable or disable the rain sensor control function.

GLOSSARY

INDOOR CONTROLLER MODEL

SELECTION DIAL

Used for operations & programming

LCD DISPLAY

Easy to read display

PROGRAMMING BUTTONS

Used for adjusting the programmed information

RAIN SENSOR SWITCH

Manually activate rain sensor by switching to ON/OFF position

FUSE LOCATION

Remove cover to access fuse

TERMINAL COVER

Remove to access terminals for solenoid (valve) wires and replace 9 volt block battery annually



PROGRAMMING INSTRUCTIONS

INTRODUCTION

This controller has been designed with four separate program starts, to allow different areas to have their own individual watering requirements.

A start is basically a method of grouping stations (valves) with similar watering requirements to water on the same days. These stations will water in sequential order from the lowest number at the start time (or times) and on the days selected.

THE KEY ELEMENTS WHEN PROGRAMMING YOUR CONTROLLER ARE:

1. Grouping the stations (valves)

Group together areas which have similar watering requirements. Examples are: Turf Areas, Flower Beds, Pergola/Undercover Areas, or Gardens. These different groups require individual settings.

2. Planning out your watering program.

Complete your individual watering planner, supplied at the back of this book.

3. Setting the current time and correct day of the week.

4. Setting an automatic program start.

Use the following 3 steps to program each group.

4.1 Set Start(s).

This sets the time of the day when watering program will commence.

4.2 Set Watering Days.

These are the days when the automatic system will be active.

4.3 Set Station Run Times.

This sets the watering duration required for each station (valve).





PROGRAMMING INSTRUCTIONS

OTHER FUNCTIONS

This controller can also manually run a selected program once, or an individual station can be set to run once from 1 minute up to 12 hours and 59 minutes. A test for checking the valves and sprinklers is also provided.

GENERAL TIPS FOR EASY PROGRAMMING

Tips to help eliminate programming confusion.

- Complete the spare watering planner.
- When setting, one push of the button will increment one unit.
- Holding one button down will fast scroll through units.
- During programming, only the flashing values are able to be set, use the  or  buttons.
- **Pressing**  will scroll forward through the settings in an orderly sequence.
- **Pressing**  will scroll back to previous settings and settings can be changed.

Basic Control Operation

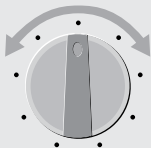

Turn dial to
required setting



Scroll Forward



Increase Value



Decrease Value





Scroll Backwards

PROGRAMMING

SET CURRENT TIME & CORRECT DAY

Turn the dial to **Set Clock/Calendar** position.

The minutes will be flashing. Use  or  to adjust.

Press the  button and the "hours" will flash.

Use  or  to adjust.



Press  and the "day of the week" will flash.



Use  or  to set correct day.



SET CALENDAR (OPTIONAL)

NOTE: The calendar only needs to be set when selecting ODD/EVEN day watering in areas where water restrictions may require this feature.

Press the  button until the year, month & day are shown.

The "year" will be flashing. Use  or  to adjust.

Press  button and the "month" will flash. Use  or  to adjust.

Press  button and the "day" will flash. Use  or  to adjust.

TIP: To return to the clock, Press  or turn dial to another position.

Before proceeding, ensure your watering planner has been completed. From this, you should be aware of which stations are allocated to each program.

NOTE: Set one program at a time – this will ensure that all the values are entered correctly.

PROGRAMMING

SETTING PROGRAM 1

The program number can only be set/changed in the **Set Start Times** position.

STEP 1. SET START TIMES

All valves will activate in sequential order for each start time.

Turn the dial to **Set Start Times** and ensure that "Prog 1" is flashing.

THE DISPLAY WILL SHOW:

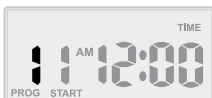

Press  and "Start 1" will flash.



Press  and the "hour" will flash.

Use  or  to adjust.

NOTE: AM / PM is set correctly.

Press  and the "minutes" will flash. Use  or  to adjust.





Each program has up to four start times and should you require a second start time, **press**  twice & "Start 1" will flash.

Advance to start 2 by pressing .

THE DISPLAY WILL SHOW:



Press  and proceed as per setting **Start 1**.

TIP: To turn an active start time off, turn the dial to the Set Start times position, select the start number required using the  button and then press  until the "hour" is flashing. Use  or  until "OFF" is shown.

TIP: "OFF" position is between 12 and 1pm.

PROGRAMMING

STEP 2. SET WATERING DAYS

This unit has individual day selection, or a 365 day calendar with odd/even day selection in areas where water restrictions require this feature, or interval watering from every day to every 15th day

Turn the dial to **Set Watering Days**.





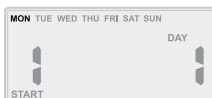

INDIVIDUAL DAY SELECTION

This is the selectable day option.

THE DISPLAY WILL SHOW:



This refers to Mon being Day 1.



To turn Monday off, **press**  button. To leave Monday active, leave as is and advance to Tuesday (day 2) by **pressing** the  button. Again **press** the  button to set the day off if required followed by to  advance. Continue until all seven days have been set "on"  or "off" .

ODD / EVEN DAY SELECTION (OPTIONAL)

In some areas, users are only allowed to water on ODD dates if their house number is ODD, or on EVEN dates when their number is EVEN. This controller allows this to be done simply by setting the relevant selection of ODD or EVEN and setting the current date into the controller.

If you require the ODD / EVEN day option, simply **press** the  button until "EVEN" is shown. **Press** the  button and "ODD" will be shown. **Press** the  button and "ODD-31" will be shown. This feature may be required in areas where water restrictions are enforced.

NOTE: Remember to set the 365 day calendar when setting the clock, or this feature will be out of sequence.

PROGRAMMING

INTERVAL DAY SELECTION

If you require the interval day option, simply **press** the  button until

THE DISPLAY WILL SHOW:

"Interval 1" will be flashing.

This means that watering will occur every day.

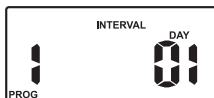

To change the interval day, **press** the  button.

EXAMPLES: Interval 2 means watering will take place every second day, 3 means watering will be every third day etc. Interval watering can be set from everyday to every 15th day.

STEP 3. SET STATION RUN TIMES

This is the length of time that each station (valve) is set to water on a particular program. Maximum watering time is 12 hours 59 minutes for each station. A station can be assigned from 1 to 4 programs if required, with different run times.

Turn the dial to the **Set Station Run Times** position.

THE DISPLAY WILL SHOW:





This means station 1 is set to "OFF" in program 1.





"Station 1" will be flashing.

PROGRAMMING

STEP 3. SET STATION RUN TIMES. (CONTINUED)

To adjust the **Run time** in minutes press , and use  or .

To set the run time in hours, press  and "0" will appear and flash.

To adjust use  or . If not required, press  and advance to station 2 by pressing the .

Continue until all the stations in Program 1 have been set with a run time, or if a station (or stations) are not required to be active in this particular program, ensure that the run time is set to "OFF".

NOTE: To set a station to "OFF".

Use  when the "RUN TIME" is flashing "OFF" position is between 12 and 1 p.m. This completes the setting up procedure for automatic watering of Program 1.

Should you need a second program:

Turn the dial to "Set Start Times" and "Prog 1" will flash. Press  and change to program 2 position and follow the same 3 steps to set an automatic watering program.

1. Set Starts

2. Set Watering Days

3. Set Station Run Times

TIP: Remember to return the dial to the "Auto Run" position after completing the set up of an automatic program. This will ensure that the automatic cycles will take place.

MANUAL OPERATIONS

SYSTEM TEST

Turn the dial to **Run Test Cycle**.

There will be a two second pause.

THE DISPLAY WILL SHOW:



Use this feature to check that your valves & sprinklers are working correctly. The unit will run all stations in sequential order. The factory preset time of 2 minutes per station can be adjusted. The new adjusted run time will become the new default time. Use **+** or **-** to adjust and **→** to advance.

TIP: If the water supply is from a pump system, it is critical to ensure all outputs are connected to a valve. Any output NOT connected to a valve, should be linked back with a wire to the nearest output with a valve.

This prevents the pump running against a closed head.

USE ONLY 1 AMP FUSE M-205

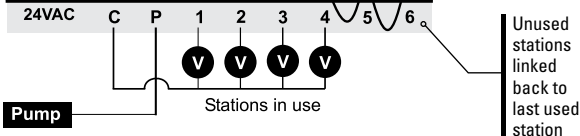

RUN A SINGLE STATION

Turn the dial to **Run Single Station**. There will be a two second pause.

Use **+** to advance to the required station and **→** to adjust the run time, then **+** or **-**. Maximum run time is 12 hours 59 minutes.

THE DISPLAY WILL SHOW:



MANUAL OPERATIONS (CONT.)

RUN A PROGRAM

To manually run a complete program once for the run times as set in the automatic schedule **turn** the dial to the **Run a Start** position. "Prog 1" will be shown in the display. To run program 1, leave or advance to start 2 by **pressing** .

OTHER FEATURES

STOP

To stop an automatic or manual watering schedule, **turn** the dial to the *Off* position.

***TIP:** For automatic watering, remember to turn the dial back to the Auto Run position. The Off position will stop any watering from occurring.*

STACKING START TIMES

Should you accidentally set the same watering start time on more than one program, the controller will stack them in sequential order from the lowest number. All programmed start times will be watered.

AUTOMATIC BACK UP PROGRAM

When the battery is not fitted or is flat during a power outage, the automatic programs will be retained in a permanent memory chip. Also the clock time will be retained in the memory at the time of the outage.

A standard 9 volt battery should be fitted to the battery snap supplied to maintain the clock accuracy and hold the automatic programs during power outs.

***TIP:** The display has a warning indicator to let you know when the battery is low or not fitted. The word BAT is displayed under the AM / PM indicator in the clock mode.*

OTHER FEATURES

RAIN SENSOR

A rain sensor can be wired directly into the terminal block. When the sensor is wet, all **automatic** and **manual** watering will not operate.

To connect a rain sensor follow this procedure:

1. **The sensor switch, accessed on the fascia, must be up in the "on" position. To over-ride the sensor when it is wet, simply move the sensor switch down to the "OFF" position. This will allow automatic and manual watering cycles to operate.**



2. **Connecting the rain sensor wires:**

A. Remove the link connector by loosening both screws and slide out. (Link located under the terminal cover.)

B. Run the new sensor wires into the terminal block and replace where the link was. Fasten one wire under the common (C), the other into the 24VAC. Polarity not applicable.

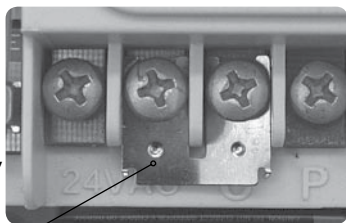

Remove link connector

New Sensor wires

NOTE: Far left 24VAC Terminal is active.

TIP: It is important to move the sensor switch back to the "on" position after completing your watering cycle.

OTHER FEATURES

RAIN OFF MODE

To stop the automatic watering cycles during winter, turn the dial to the **Off** position. The word “Off” will appear in the display. This means the automatic programs will not come on, but the programmed information is still retained in the memory. To reactivate the automatic schedule, **turn** the dial back to the **Auto Run** position.

WATER BUDGETING

The automatic station run times can be adjusted by percentage as the seasons change. This will save time and money as the run times can be adjusted quickly in spring, winter and autumn to reduce the amount of water used.

Ensure that the dial is in the **Auto Run** position and then press the  button.



THE DISPLAY WILL SHOW:

Displayed is the word “Budget” and “100%”.



This represents the current automatic watering run times as being 100%. The percentage budget can be set in 10% increments from 10% to 200%.

Example: 50% reduces watering by half.

To adjust in 10% increments, use  or  buttons.

To return to the clock press the  button. The display will show the word Budget to indicate that the water budgeting feature is in use.

INSTALLATION INSTRUCTIONS

MOUNTING THE CONTROLLER

This controller unit is an INDOOR MODEL and MUST not be exposed to rain or water ingress, or direct sunlight.

Install the controller near a 120VAC (240VAC International) outlet, preferably located in a house, garage or other covered area. For ease of operation, eye level placement is recommended.

Drive one #8 screw into the wall, leaving about 1/8 inch (4mm) of the screw exposed. If necessary, use a toggle bolt or masonry shield.

Hang the controller from the key slot located in the back of the case. Make sure the head is properly seated inside the controller case. Additional screws may be inserted through the holes in the lower corners of the controller case.

ELECTRICAL HOOK-UP

WARNING

1. All electrical work must be carried out in accordance with these instructions following all applicable Local, State and Federal codes, or warranty will be void.
2. Disconnect power supply before maintenance work to controller or valves and when connecting and disconnecting field wiring and pump or master valve hook-ups.

INSTALLATION INSTRUCTIONS

FIELD WIRING CONNECTIONS

PREPARATION

1. Prepare wires for hook-up by cutting the wires to the correct length and stripping approximately ¼ inch (6mm) of insulation from the end to be connected to the controller.
2. Ensure terminal block screws are loosened sufficiently to permit easy access for wire ends. Insert stripped wire ends into the clamp aperture and tighten screws. **Do not over tighten** as this may damage the terminal block.
3. A maximum of 0.75 Amps may be supplied by any output. Check the inrush current of your solenoid coils before connecting more than two valves to any one station.

TERMINAL BLOCK LAYOUT

THE TERMINAL BLOCK IS LAID OUT AS FOLLOWS:

USE ONLY 1 AMP FUSE M-205

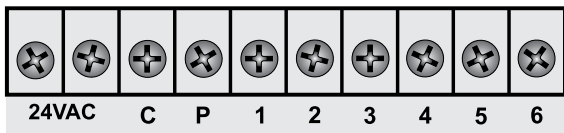

GLOSSARY

- 24VAC** 24VAC Power Supply
C Common valve wire input
P Master valve or pump start active wire
1 to 6 Station (Valve) active wire connection

INSTALLATION INSTRUCTIONS

POWER SUPPLY CONNECTIONS

The controller itself can run off a 120VAC (240VAC International) to 24VAC external.

It is recommended that the transformer is not connected to a 120VAC (240VAC International) supply which is also servicing or supplying motors (i.e. Air conditioners, pool pumps, refrigerators, etc.) Lighting circuits are suitable as a power source.

CONNECTIONS TO THE UNIT ARE AS FOLLOWS:

USE ONLY 1 AMP FUSE M-205

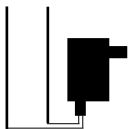
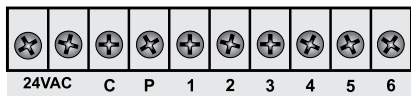

CONNECTION OF VALVES

Up to two 24VAC Solenoid Valves can be connected to each station output and wired back to the common (C) thus:

USE ONLY 1 AMP FUSE M-205

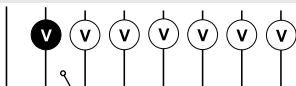
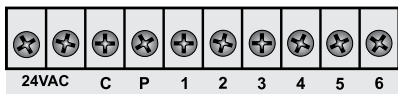

Valve wires enter the controller through the rear.

INSTALLATION INSTRUCTIONS

PUMP HOOK-UP CONNECTIONS

Do not attempt to drive a pump starter directly from the controller.

Pump start is provided by connecting one side of the coil of a suitable relay to the Master Valve/Pump Start output of the controller and the other side to the controller common.

For systems supplied with water from a pump, unused stations must be connected back to the last used station to eliminate the possibility of the pump running against a closed head. Failure to do so could lead to pump damage.

The diagram shows an 6 station controller with 4 active stations (valves):

USE ONLY 1 AMP FUSE M-205

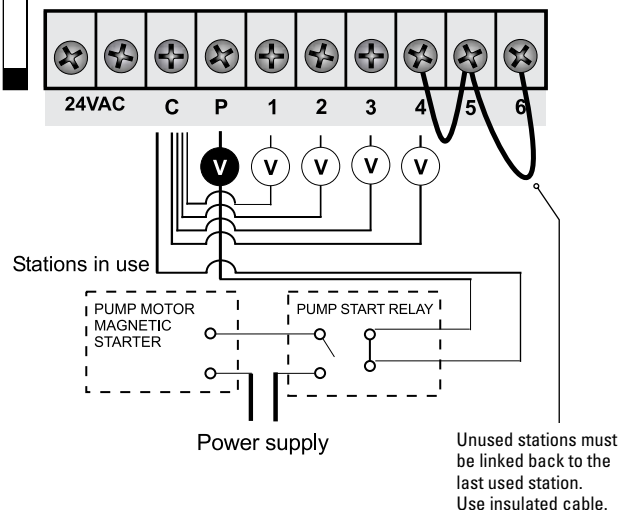

ELECTRICAL CHARACTERISTICS

POWER SUPPLY

This unit can run off a external transformer, (plug pack), with an output of 24VAC 50 Hz / 60 Hz @ 1.0 Amp.

PLUG PACK MODEL

The correct wiring installation for the 24VAC plug pack is shown on page 16. The plug pack model is only **suitable for indoor installation.**



ELECTRICAL OUTPUTS

ELECTRICAL POWER SUPPLY

- Input: 24Volts AC 50 Hz / 60 Hz. Electrical
- Outputs: Maximum of 1.0 AMPS
To Solenoid Valves: 24VAC 50/60 Hz 0.5 AMPS max.
To the Master Valve/Pump Start: 24VAC 0.25 AMPS maximum.

NOTE: Transformer & fuse capacity must be compatible with output requirements.

- Overload protection: Standard 20mm 1 Amp fuse.
- Power failure: 9 Volt battery maintains clock and programs for up to 4-6 weeks.
- Permanent memory chip will hold the programs and last clock time before the power outage, if the battery is not fitted or flat.

NOTE: To clear the programs in the memory, turn the dial to "OFF" position and press   buttons simultaneously. The controller memory will be cleared.

- The output circuits should be installed and protected in accordance with wiring rules.

SERVICING THE CONTROLLER

The controller should always be serviced by an authorized agent.

FOLLOW THESE STEPS:

1. Turn power off to the controller.
2. Disconnect 24 Volt power leads from the plug pack at the controller 24VAC terminals.
3. Clearly mark or identify all valve wires according to the terminals they are connected to, (1 to 6). This allows you to easily wire them back to the controller, maintaining your valve watering sequence.
4. Disconnect valve wires from the terminal block.
5. Remove the complete unit from the wall.
6. Carefully wrap the complete unit in protective wrapping and pack in a suitable box. Return to your service agent or the manufacturer.



NOTE: *Tampering with the unit will cancel the Warranty.*

7. Replace your controller by reversing this procedure.

TROUBLESHOOTING

SYMPTOM	POSSIBLE CAUSE	SUGGESTION
No display.	Faulty transformer. Fuse blown.	Check fuse. Check field wiring. Check transformer.
Single Station not working.	Faulty solenoid coil.	Swap faulty station wire on controller terminal block with known working station wire. If the faulty valve still does not work on the known working connection then the solenoid coil is faulty. The panel may need to be repaired.
Fuse blows.	Incorrect wiring/bad wiring connection.	Check wiring and connections.
No automatic start.	Incorrect programming or blown fuse.	If unit works manually check programming. Check fuse/field wiring.
Buttons on keypad not responding.	Short on keypad or programming not correct.	Check instruction book to ensure programming correct. If keypad still not responding return panel to supplier or manufacturer.
System coming on at random.	Too many start times entered on automatic programs.	Check number of start times entered on each program. If programming is correct return panel to supplier/manufacturer.
More than 1 station coming on at once.	Damaged main output driver chip.	Check wiring and swap faulty station wire(s) on controller terminal block with known working station wire. If the same outputs are still locked on, return panel to supplier/manufacturer.
Pump start chattering.	Faulty relay or pump contactor.	Electrician to check voltage on pump relay or contactor.
Display cracked or missing segments.	Display damaged during transportation.	Return panel to supplier

SPARE WATERING PLANNER

VALVE NUMBER & LOCATION				
1		4		
2		5		
3		6		
PROGRAM				
	START TIME	WATERING INTERVAL	STATION	RUN TIME (minutes)
1	Start Time 1:		1	
	Start Time 2:		2	
	Start Time 3:		3	
	Start Time 4:		4	
			5	
2	Start Time 1:		1	
	Start Time 2:		2	
	Start Time 3:		3	
	Start Time 4:		4	
			5	
3	Start Time 1:		1	
	Start Time 2:		2	
	Start Time 3:		3	
	Start Time 4:		4	
			5	
4	Start Time 1:		1	
	Start Time 2:		2	
	Start Time 3:		3	
	Start Time 4:		4	
			5	
			6	

WARRANTY

The manufacturer guarantees to the original purchaser that any product supplied by the manufacturer will be free from defects in materials and workmanship for a period of two years from the date of purchase. Any product found to have defects in material or workmanship within the period of this warranty shall be repaired or replaced by the manufacturer **FREE OF CHARGE.**

The manufacturer does not guarantee the use for a particular purpose of its products and does not make any guarantee, expressed or implied, other than the warranty contained herein. The manufacturer shall not be liable for any loss from use of the product or incidental or consequential damages including damages to other parts of any installation of which this product is part.

The warranty shall not apply to any equipment which is found to have been improperly installed, set up or used in any way not in accordance with the instructions supplied with this equipment, or to have been modified, repaired or altered in any way without the express written consent of the manufacturer. This warranty shall not apply to any batteries or accessories used in the equipment covered under this warranty or to any damage which may be caused by such batteries.

If the Controller develops a fault, the product or panel must be returned in adequate packing with:

1. A copy of your original invoice.
2. A description of any fault.

It is the purchasers responsibility to return the controller to the manufacturer or their agent by prepaid freight.



K-Rain Manufacturing Corp.

1640 Australian Avenue

Riviera Beach, FL 33404

(561) 844-1002

(561) 842-9493 FAX

(800) 735-7246 / www.krain.com